

***OPERATION AND MAINTENANCE  
MANUAL***

***- ORIGINAL INSTRUCTIONS -***

**MIDIREEL**

## EC DECLARATION OF CONFORMITY

In compliance with the Machinery Directive 2006/42/EC, Annex II, Part A, the manufacturer

represented by the person in charge of the technical documentation  
..... working at

DECLARES under its own responsibility that the machine

### **MIDIReel**

commercial name: *MIDIReel*  
function: *Retractable hose reel*  
model: *Closed*  
type: *Square 3 meters / Square 4 meters / Square 6 meters*  
series number: .....

meets the provisions of Directive 2006/42/EC of the European Parliament and of the Council of 17 May 2006 on machinery (Machinery Directive), and amending Directive 95/16/EC (recast);

The following harmonized standards have been considered and applied: UNI EN ISO 12100

San Quirino (PN), \_\_\_\_/\_\_\_\_/\_\_\_\_

The legal representative

\_\_\_\_\_  
.....

# 1. Table of contents

<b>1. TABLE OF CONTENTS .....</b>	<b>3</b>
<b>2. MACHINE IDENTIFICATION .....</b>	<b>5</b>
2.1. MACHINE TECHNICAL DATA .....	5
<b>3. INTRODUCTION .....</b>	<b>6</b>
<b>4. PRELIMINARY WARNINGS .....</b>	<b>7</b>
4.1. WARNINGS ON GENERAL OPERATIONS AND USE OF THE MACHINE .....	7
4.2. TERMINOLOGY AND DEFINITIONS .....	8
4.3. WARNING SIGNS .....	9
4.4. PRELIMINARY VERIFICATION .....	9
<b>5. LIMITS AND REQUIREMENTS .....</b>	<b>10</b>
5.1. OPERATORS QUALIFIED TO USE THE MACHINE .....	10
5.1.1. <i>Personal protective equipment</i> .....	10
5.1.2. <i>Personnel in charge of transport, installation, dismantling and commissioning</i> .....	11
5.1.3. <i>Personnel in charge of maintenance and repair</i> .....	12
5.1.4. <i>Personnel in charge of operation</i> .....	12
5.2. POSSIBILITIES AND LIMITS OF USE .....	13
5.3. SPACE LIMITS .....	13
5.4. LIMITS OF THE OPERATOR WORKSPACE .....	13
5.5. DANGER ZONES .....	13
5.6. ENVIRONMENTAL REQUIREMENTS .....	14
5.7. WATER SUPPLY REQUIREMENTS .....	14
5.8. NOISE .....	15
5.9. LIGHTING .....	15
<b>6. MACHINE DESCRIPTION .....</b>	<b>16</b>
<b>7. CONTROL AND SIGNALING DEVICES .....</b>	<b>17</b>
<b>8. TRANSPORT .....</b>	<b>18</b>
<b>9. INSTALLATION AND COMMISSIONING .....</b>	<b>19</b>
9.1. MACHINE INSTALLATION .....	19
9.1.1. <i>Wall mounting</i> .....	19
9.2. WATER CONNECTION .....	21
9.3. COMMISSIONING .....	22
<b>10. SHUTDOWN .....</b>	<b>23</b>
<b>11. HOW TO USE THE MACHINE .....</b>	<b>24</b>
11.1. WORK CYCLE EXECUTION .....	24
<b>12. CLEANING .....</b>	<b>26</b>
12.1. GENERAL MACHINE CLEANING .....	26
12.2. CLEANING OF FLOOR AREAS .....	26
<b>13. MAINTENANCE AND LUBRICATION .....</b>	<b>27</b>
13.1. WARNINGS ON WORK PREPARATION AND PERFORMANCE .....	27
13.2. SAFETY INSTRUCTIONS FOR INSPECTION AND MAINTENANCE WORK .....	28
13.3. SPARE PARTS REPLACEMENT .....	28
13.4. DISASSEMBLING-ASSEMBLING THE INLET UNIT (ELBOW CONNECTOR) .....	29
13.4.1. <i>Disassembling the inlet unit (elbow connector)</i> .....	29
13.4.2. <i>Assembling the inlet unit (elbow connector)</i> .....	30

13.5.	UNLOADING-LOADING THE RETRACTION SPRING .....	31
13.5.1.	<i>Unloading the retraction spring</i> .....	31
13.5.2.	<i>Loading the retraction spring</i> .....	32
13.6.	REMOVING-REPLACING THE HOSE ON THE PULLEYS .....	33
13.6.1.	<i>Removing the hose on the pulleys</i> .....	34
13.6.2.	<i>Replacing the hose on the pulleys</i> .....	35
13.7.	REMOVING-REPLACING THE TOOTH SPRING.....	37
13.8.	EXTRAORDINARY MAINTENANCE .....	38
<b>14.</b>	<b>DISPOSAL OF THE MACHINE AND ITS PRODUCTS.....</b>	<b>39</b>
<b>15.</b>	<b>RESIDUAL RISKS .....</b>	<b>40</b>
15.1.	INTRODUCTION.....	40
15.2.	TRANSPORT RISKS .....	40
15.3.	RISKS DUE TO ASSEMBLY ERRORS .....	40
15.4.	RISKS DUE TO POOR LIGHTING.....	41
15.5.	RISKS OF SLIPPING AND FALLING .....	41
15.6.	RISKS DURING MAINTENANCE .....	41
<b>16.</b>	<b>ANNEXES .....</b>	<b>42</b>
<b>17.</b>	<b>ANNEX 1 - EXTRAORDINARY MAINTENANCE .....</b>	<b>43</b>
17.1.	OPENING-CLOSING THE SHELLS .....	43
17.1.1.	<i>Opening the shells</i> .....	44
17.1.2.	<i>Closing the shells</i> .....	45
17.2.	REPLACING THE RETRACTION SPRING.....	47
17.2.1.	<i>Disassembling the retraction spring</i> .....	47
17.2.2.	<i>Assembling the retraction spring</i> .....	49
<b>18.</b>	<b>ANNEX 2 - MACHINE TECHNICAL DRAWINGS.....</b>	<b>51</b>

## 2. Machine identification

**Manufacturer:**

**Machine:** MIDIReel

**Model:** Closed SQUARED

**Year of construction:** .....

The CE marking plate identifies the manufacturer, is made of fireproof and durable material (aluminum), and is firmly attached to the machine frame.



**Unauthorized reproduction of all or part of this Manual is expressly forbidden.**



**This Manual and all accompanying documents have been checked before sale. Please inform the manufacturer in case of errors or inaccuracies.**

### 2.1. Machine technical data

Please refer to the technical drawings annexed herewith.

### 3. Introduction



**This Manual must be kept for future reference.**

**These instructions are mainly intended for the operator(s), who should read them carefully before starting any operation with the machine. If the operators are of a different nationality, instructions must be translated into their mother tongue. Knowledge of the provisions herein contained does not relieve the reader from understanding and getting familiar with any further documentation and/or manuals on the machine.**

**Instructions must be available for consultation whenever needed by the operators and must be carefully stored in a dry and accessible place near the area where the machine is located. The Plant Manager and Safety Officer must be familiar with the contents of this Manual and its Annexes.**



**These instructions must be stored throughout the working life of the machine. This Manual must be updated whenever significant changes are made to the machine. The manufacturer will not be held responsible for any faults occurring because of non-compliance with the instructions herein contained. If necessary, further copies or updates of this Manual should be requested to the manufacturer. In case of doubt, please contact the manufacturer or importer for clarification.**



**Before making any modifications to the machine, contact the manufacturer or importer to clarify whether it is feasible without changing its characteristics or safety conditions.**

**If substantial changes are made to the machine, the machine certification shall not be valid, and any warranty provided or agreed upon shall be void.**

## 4. Preliminary warnings

### 4.1. Warnings on general operations and use of the machine



**Read and become thoroughly familiar with the following instructions to avoid any personal injury or property damage.**

- a) In order to prevent accidents, this machine must be operated **ONLY** by trained and qualified personnel.
- b) Only trained personnel should operate this machine. Untrained personnel should never operate this machine.
- c) Maintenance must be performed by trained personnel. Maintenance and repair must be performed by trained and qualified personnel. If these operations are performed by untrained personnel, they may cause serious accidents to both personnel and the machine.
- d) Personal protective equipment. Do not operate the machine without the personal protective equipment prescribed in this Manual.
- e) Lighting. Do not operate the machine under inadequate outdoor lighting conditions.
- f) Warning signs. Signs are affixed to the machine to warn of hazards and obligations. Regularly check that signs are intact and replace them if necessary.
- g) Keep the operator's work area free of foreign material and clear of any obstacles that may cause tripping.
- h) Select a location with adequate clearance to perform regular maintenance under safe conditions.
- i) The retractable hose is made of EPDM rubber. This type of rubber must NOT come into contact with oils, fuels, aromatic and/or aliphatic hydrocarbons, halogenated solvents, and concentrated acids as they may deteriorate the hose.
- j) The MIDIREel hose has been tested and is warranted only if it is used with water NOT mixed with other substances. The manufacturer does not guarantee the tightness and durability of the hose if it used under conditions other than those outlined.

For more detailed information on the work environment and installation, please refer to the relevant chapters of this Manual.



**Do not operate the machine until you have performed a proper inspection.**

**Qualified personnel are not allowed to operate the machine if they take substances reducing reaction time.**

**Personnel must not "self-train" for specific tasks using documentation or based on experiences concerning machines which are different from the one covered by this Manual.**



**Maintainers or repairers should have thorough knowledge of the machine and of the necessary safety requirements, as the machine could be under special conditions when they are asked to intervene. They must protect both themselves and all the operators working in the area where the machine is located.**

## 4.2. Terminology and definitions

For the purposes of this Manual:

**safeguards** are safety measures implying the use of specific technical means called guards (such as shelters or safety devices) to protect people from hazards that cannot be reasonably eliminated or sufficiently limited by design;

**guard** means a part of the machine used specifically to provide protection by means of a physical barrier. A guard can be called casing, cover, screen, door, fence, etc. depending on how it is made;

**fixed guard** means a guard held in place (i.e., closed) either permanently (by welding, etc.) or by means of fasteners (screws, bolts, etc.) that make it impossible to remove/open without using tools;

**danger zone** means any zone within or around the machine in which a person might put his health or safety at risk;

**exposed person** means any person wholly or partially in a danger zone.

From now on, unless otherwise specified, the general term **MACHINE** shall refer to the machine described in this Manual whose commercial name is "MIDIReel", as indicated in the cover page.



### 4.3. Warning signs

For clarity purposes, symbols have been used in this Manual to convey the meaning and importance of the information provided to the readers.

In general, three different types of signs have been used:



A triangle with a border

#### **Danger signs**

Provide instructions on actual or potential dangers



A circle with a diagonal bar

#### **Prohibition signs**

Provide instructions on actions that should be avoided



A solid circle

#### **Obligation signs**

Provide information which is important to read and to comply with

Depending on the information to be conveyed, the signs may contain symbols which - by association of ideas - help readers understand the type of danger, prohibition, or obligation.

### 4.4. Preliminary verification

Inspect the machine carefully and become familiar with it to make sure that all the instructions provided in this Manual and in its Annexes perfectly match with the machine configuration.

If any discrepancies are identified, the manufacturer should be contacted for assistance to obtain the technical information needed to operate the machine.

Any supplementary documentation on the machine shall be fully attached to all copies of this Manual and shall be considered an integral part thereof.

Any information provided by the manufacturer shall prevail over any conflicting instructions in this Manual. However, in case of conflict, the problem should be brought to the attention of the manufacturer, especially if it may affect the machine safety or the operator's safety.



**Do not operate the machine until you have performed a proper inspection.**

## 5. Limits and requirements

### 5.1. Operators qualified to use the machine

The machine should only be used by professional operators, who have been trained in the following tasks:

- a) transport;
- b) installation and commissioning;
- c) operation;
- d) maintenance and repair;
- e) cleaning;
- f) dismantling.

All operators must have been specifically instructed to perform their duties and practically trained to perform them.

They must have both specific knowledge of the machine and general knowledge of the safety rules and necessary tools to perform their work, and must have gained sufficient experience to perform their duties independently.



**Qualified personnel are not allowed to operate the machine if they take substances reducing reaction time.**

**If the machine owner cannot provide sufficient training to personnel, it shall request the manufacturer or vendor to train its personnel appropriately.**

**Personnel must not "self-train" for specific tasks using documentation or based on experiences concerning machines which are different from the one covered by this Manual.**



**Knowledge of the instructions herein contained is mandatory but does not replace the experience required of the operators.**

#### 5.1.1. Personal protective equipment

To prevent any risks that may be generated by the machine, all subjects who operate it must be provided with appropriate personal protective equipment, such as:

- a) gloves, if required for a specific type of spray valve;
- b) anti-slip safety footwear for a specific work environment where the floor may be covered with water.



**Knowledge of the instructions herein contained is mandatory but does not replace the experience required of the operators.**

**Operators should be professionally trained in the use of PPE and instructed on the risks they may face without it.**



**Operators must wear rubber gloves to prevent slipping while holding the spray valve.**

**Moreover, they must use protective gloves during maintenance against cut hazards.**



**Operators' footwear must provide secure grip even when the floor is covered with water.**

**Operators' footwear must not be worn out and must be suitable for walking surfaces.**



**In addition to the above-mentioned PPE, operators must wear safety goggles during maintenance when disassembling the retraction spring.**

#### 5.1.2. Personnel in charge of transport, installation, dismantling and commissioning

It is necessary to set up and coordinate a working group consisting of all the people - working inside or outside the company - who can perform the required tasks to complete the various steps set out in the relevant chapters of this Manual.

All personnel must be coordinated by a Supervisor to ensure perfect cooperation and synergy in pursuit of the expected result.



**All personnel who are entrusted with performing specific tasks must not - under any circumstances - perform any other tasks which they are not in charge of.**



**The working group must be coordinated so that each operator or group of operators in charge of a specific task can work independently.**



**Operations carried out by unqualified personnel may be dangerous.**

#### 5.1.3. Personnel in charge of maintenance and repair

Personnel performing these duties must be able to:

- a) assess the efficiency conditions of the machine;
- b) identify any faults;
- c) keep the machine efficient by carrying out regular maintenance;
- d) clean the machine, when necessary.



**Maintainers or repairers should have thorough knowledge of the machine and of the necessary safety requirements, as the machine could be under special conditions when they are asked to intervene. They must protect both themselves and all the operators working in the area where the machine is located.**

Operators may be entrusted with specific maintenance tasks according to their role, training, expertise, or experience.



**Maintenance operators should never seek help from anyone having different tasks or qualifications, as they may not have adequate training to deal with the situation without compromising their own safety and that of others.**

#### 5.1.4. Personnel in charge of operation

The machine must be operated **BY ONE OPERATOR ONLY**. The operator in charge is responsible for the machine.

The operator must never carry out interventions other than the standard operations described below. Maintenance, repair, and activities other than standard operations shall be performed by qualified personnel.



**Only maintenance personnel can reactivate the machine in case of abnormal operating conditions or other malfunctions.**



**Do not try to solve abnormal situations that are not strictly related to operating tasks.**

**Do not help maintenance personnel under any circumstances.**

### **5.2. Possibilities and limits of use**

The “MIDIReel” is a closed squared hose reel provided with a spray gun. It has been designed for use in professional kitchens, workshops, and environments where it is necessary to use a heavy-duty spray gun to rinse and clean large surface areas. Operations are made easy and fast by the hose, which can be used at the set length and can be easily retracted once cleaning operations have been completed.



**It is forbidden to use the machine for operations other than those listed above.**

### **5.3. Space limits**

The overall dimensions of the machine are shown in the annexed technical drawings.

### **5.4. Limits of the operator workspace**

There are no workstations for operators using the machine.

### **5.5. Danger zones**

In addition to the danger of dropping the machine during installation, the only danger zone is the spring inside the MIDIReel. In any case, the spring is protected by the MIDIReel protective casing.

As for other operations (cleaning, maintenance, etc.), any area under the risk of bump, fall or any other impact resulting from operations can be considered a danger zone.

Please refer to the instructions in the chapter concerning each specific operation.

### 5.6. Environmental requirements

The machine working area must be kept clean and must meet the lighting requirements outlined in the chapter below.



**This machine must operate in an area meeting the following requirements.**

**Faults or malfunctions may occur if it is used outside the limits below.**



**The machine cannot be used in an explosive atmosphere. Therefore, it is forbidden for the user to operate the machine in an explosive or partially explosive atmosphere.**

Temperature range	0°C / 40°C
Ambient temperature changes	Max. 1.1°C/min.
Maximum height	1,000 m

The machine should not be exposed to vibrations, high-frequency noise, dust, or foreign material which may cause deterioration or mechanical failure. It should also not be exposed to weather conditions (rain, hail, fog, snow, etc.).

### 5.7. Water Supply Requirements



**Do not use pressure pumps. The MIDIReel operates only at standard water supply pressure.**

Water pressure limits for the hose reel are outlined below:

Min. water pressure	0.1 MPa (1 bar)
Max. water pressure	0.6 MPa (6 bar) static
Recommended water pressure	from 0.25 MPa to 0.6 MPa



**Do not use water with a temperature above 90°C.**

Water temperature limits for the hose reel are outlined below:

Max. water temperature		90°C
Recommended temperature	water	< 65°C

### **5.8. Noise**



**It is not mandatory to wear hearing protection equipment for the noise produced by the machine.**

The machine does not produce noise requiring the use of hearing protection equipment.

### **5.9. Lighting**

The machine requires sufficient external lighting for all standard operations. The illumination values required are the same as those required for average visual performance (200 lux).

## **6. Machine description**

The “MIDIReel” closed hose reels are provided with a spray gun and have been designed for use in professional kitchens, workshops and environments where it is necessary to use a heavy-duty spray gun to rinse and clean large surface areas. Operations are made easy and fast by the hose, which can be used at the set length and can be easily retracted once cleaning operations have been completed.



## **7. Control and signaling devices**

This machine is not equipped with control devices.

## 8. Transport



**Machine lifting and handling must be carried out ONLY by the manufacturer's qualified personnel or by personnel trained and explicitly authorized by the manufacturer.**



**The personnel in charge of lifting and transporting the machine must be qualified and trained to perform these tasks.**



**If lifting, transport and assembly operations are performed without following the Manual instructions and by unqualified personnel, machine parts may be damaged and the person performing the operation and all persons located in close proximity may be exposed to bump hazard.**

It is necessary to use extreme caution during transport. The machine is delivered fully assembled in all its parts.

The total weight of the machine is about 11kg (6 meters), 8kg (4 meters), and 7,5 (3 meters).

Due to the weight of the machine, its transport and handling at the place of installation shall be performed manually by the operator.

## 9. Installation and commissioning



Machine installation and commissioning must be carried out **ONLY** by the manufacturer's qualified personnel or by personnel trained and authorized by the manufacturer.



It is mandatory to wear appropriate personal protective equipment during installation.



The hose reel must be located in cleared areas as required for its operation.



Do not install the MIDIREel in locations where temperature may exceed the MIDimum recommended temperature (e.g., near or over heat sources), to prevent degradation of the rubber or plastic components over time.

Before installation, check that the delivery is complete and that the hose reel has not been damaged during transport or storage.

The machine must be installed in compliance with the methods and instructions described in this Manual, and in cleared areas as required.

### 9.1. Machine installation

#### 9.1.1. Wall mounting



Check in advance that the wall bracket holding the MIDIREel can support its weight and withstand the stresses of use.

- 1) Mark the positions of the four holes to fix the bracket to the wall. You can use the bracket as a marking template using a spirit level to ensure the MIDIREel is straight.



2) Drill the holes using screws and dowels that can support the weight of the MIDIREel according to the type of bracket used.

It is recommended to use M8 highbond anchors FHB II A-L with injection mortar FIS HB 345 S (bicomponent vinyl ester resin cartridge) or similar.



3) Lock the bracket to the wall.



4) Insert the rotation pins into the upper and lower housings of the wall mounting bracket and at the same time insert the MIDIREel between them on the appropriate bushings.

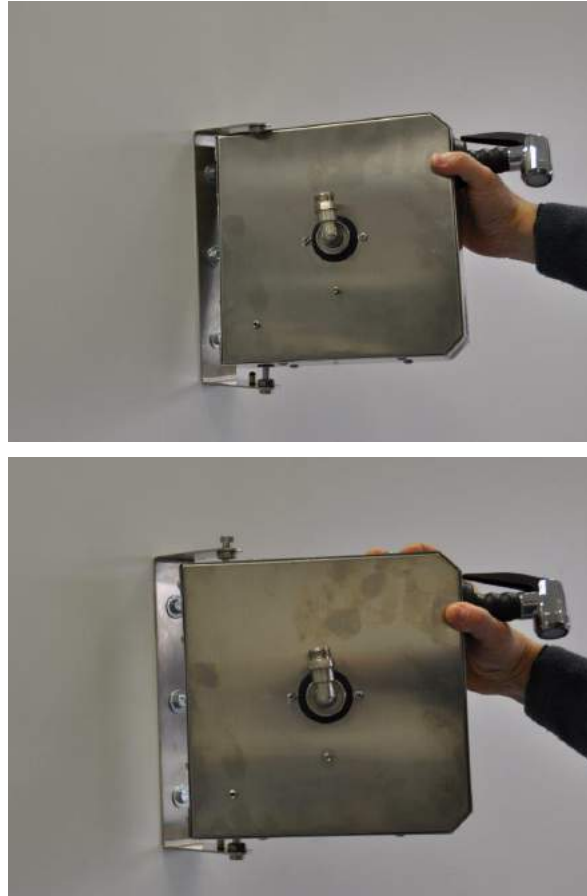

5) Tighten both pins with a 14 mm spanner

### 9.2. *Water connection*



**Install a faucet or a shut-off valve upstream of the MIDIREel to shut down the water supply to the MIDIREel in case of leakage.**



**It is the installer's responsibility to ensure that the upstream faucet or shut-off valve and the connection hose are installed in accordance with the EN 1717 standard and/or other local regulations on backflow water pollution prevention.**



**Before connecting the hose reel to the supply line, check that the operating pressure does not exceed the maximum recommended pressure.**

The water inlet located on the MIDIREel is provided with an M $\frac{1}{2}$ "G (ISO 228-1) male thread and a backflow preventer.

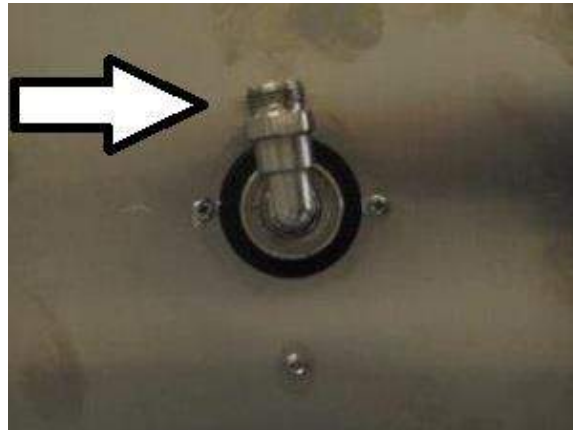

### **9.3. Commissioning**

Once the machine has been installed and the water connection has been made, it is ready for use (after opening the water supply).

## 10. Shutdown

Turn off the water supply to the MIDIREel to shut down the machine.



**Turn off the water supply to the MIDIREel whenever it is not used for a long time, especially during non-working periods.**

## 11. How to use the machine



To prevent any risks that may be generated by the machine, all subjects who operate it must be provided with appropriate personal protective equipment, as explained in this Manual.



All operators using the machine must have read and understood the instructions contained in this Manual, **AND MUST HAVE BEEN TRAINED IN ADVANCE.**

Knowledge of the instructions on how to use the machine provided in this chapter requires basic knowledge of the machine, which is acquired by reading the previous chapters.

All troubleshooting and repair operations must be performed only by authorized maintenance personnel.

### 11.1. Work cycle execution



Hold the spray gun until the hose is fully retracted to avoid possible damage to the spray gun, hose and/or people and objects nearby during hose retraction.



Turn off the water supply to the MIDiReel whenever it is not used for a long time, especially during non-working periods.

Pull the hose out to the desired length. The unit has a mechanism locking the hose at regular intervals. Slightly pull the hose to activate the spring-loaded hose retraction system.



Once the hose has been pulled out, take care not to trip if the unit is located in a transit area.



In case of leakage from the hose or the hose reel, promptly turn off the valve or the faucet located upstream of the water supply.





**Do not push the hose into the casing; let the spring-loaded system retract the hose. Forcing the hose into the casing may damage the retraction system.**



**Do not pull out the hose completely and do not continue pulling when the hose is fully pulled out. You may damage internal fittings and the hose.**

If the MIDIREel has not been used for some time, the quality of the stagnant water inside the hose may be impaired. In this case, follow the recommendations of the European Standard UNI EN 1717 under the paragraph "eliminate stagnant water using the water gun".

Rinse the hose thoroughly before using it after a long period of inactivity. It is recommended to rinse the hose for at least 30 seconds.

The hose has been tested in accordance with the requirements specified by the FDA (see 21, parts 170 to 199, article 177.2600f).

## 12. Cleaning



**Cleaning must be carried out only by qualified personnel, who are properly equipped and authorized for the purpose.**

### **12.1. General machine cleaning**

Cleaning must be carried out whenever required by the machine. It is essential to check the state of the machine on a daily basis. The machine parts should be cleaned from any residual dust or dirt with a soft cloth.

### **12.2. Cleaning of floor areas**

All areas around the machine must be kept clean at all times and kept clear of obstacles that may cause tripping.

They must be cleaned with the utmost care from any water on the floor, dirt or anything else that may lead to dangerous situations.

They must be cleaned as needed and, if suggested by the operator, several times a day.

## 13. Maintenance and lubrication



Maintenance must be performed only by **SPECIFICALLY** trained personnel.

When conducting operations, maintenance personnel must follow these safety instructions and the instructions of the machine where the partly completed machine is incorporated.



Unqualified persons are not allowed to stay in any of the danger zones. The maintenance operator shall make sure that this condition is met.



Do not open the MIDIReel spring cover nor loosen or remove any screws. Failure to comply with these instructions may be a potential danger to the operator's safety.

### 13.1. Warnings on work preparation and performance



Read the instructions of this Manual carefully before carrying out any maintenance on the machine.



Maintenance operators must wear all personal protective equipment prescribed in this Manual.



**Misunderstanding the details of inspection and maintenance operations may lead to unforeseen accidents due to failure to use tools/parts, or because work does not proceed as smoothly as it should.**

**The necessary steps must be considered, and a detailed analysis made to prepare a work plan so as to avoid unsuitable operations.**

**Each step should be explained, clarified, and its execution verified, if needed, by the working group. Operations that are performed separately may cause accidents.**



**The necessary spare parts and consumables required for inspection and maintenance operations must be prepared and kept in stock for faster intervention.**

**Spare parts must always be requested from the manufacturer if they are not available on the market.**

**The tools required for operations must always be maintained in optimum condition. Tools or equipment that are not suitable for a specific task, or that are worn out, may cause accidents.**

### **13.2. Safety instructions for inspection and maintenance work**

1. Wear appropriate work clothing during operations.
2. Provide enough space to work around the partly completed machine. Narrow spaces may cause work slowdowns or accidents.
3. The work area must be provided with appropriate lighting. It is very dangerous to work in poorly lit areas.
4. Before performing any operation with the partly completed machine, clean and tidy the entire work area removing the tools used and storing them in a safe place.

### **13.3. Spare parts replacement**

Contact the machine manufacturer to obtain spare parts.



Do not replace machine parts with non-identical parts unless you have obtained explicit approval by the manufacturer.

In case of replacement, all machine documentation must be updated.



If any intervention changes the functionality of the machine, its certification is no longer valid and the conformity assessment procedure should be repeated.



Follow the procedure explained in this Manual carefully to ensure proper maintenance.

### 13.4. *Disassembling-assembling the inlet unit (elbow connector)*

#### 13.4.1. *Disassembling the inlet unit (elbow connector)*



Before starting any operation, shut down the water supply upstream of the MIDiReel and disconnect the water inlet hose.

- 1) Remove the stop ring Seeger.



2) Remove the inlet unit.



13.4.2. Assembling the inlet unit (elbow connector)

1) Insert the inlet unit by matching the groove on the inlet unit with the pin inside the shaft.



2) Insert the stop ring Seeger inside the groove on the shaft.



3) Connect the inlet flexible hose to the inlet unit M $\frac{1}{2}$ "G of the MIDIREEL.

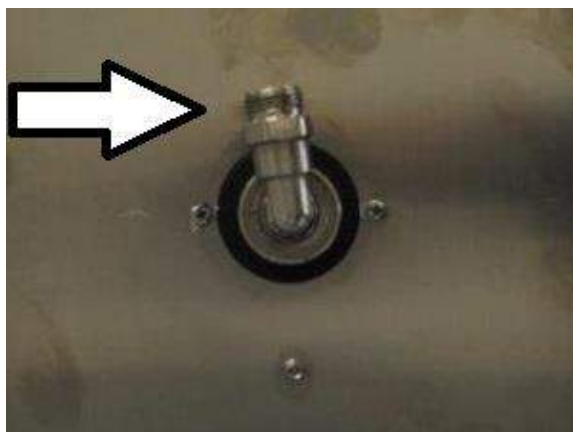

### 13.5. Unloading-loading the retraction spring



**Do not open the MIDIREEL spring cover nor loosen or remove any screws. Failure to comply with these instructions may be a potential danger to the operator's safety.**

#### 13.5.1. Unloading the retraction spring

1) Hold the hub with an 8 mm hexagonal key.



**Hold the key firmly as it may injure the operator or cause damage to nearby objects.**

- 2) Loosen the two M4 screws holding the hub.



- 3) Loosen the hub gradually by turning the hex key counterclockwise, to fully unload the spring.

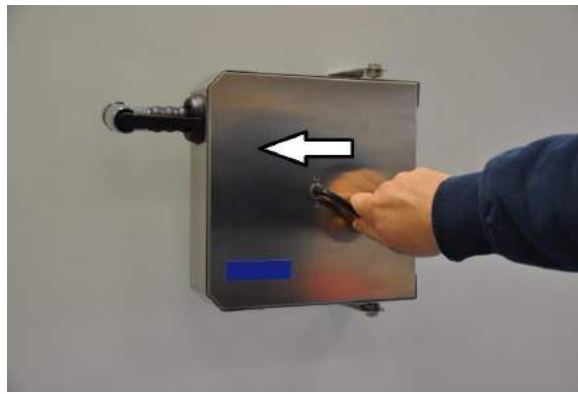

#### 13.5.2. Loading the retraction spring

- 1) Load the spring by inserting the 8 mm hex key in its slot and turning it clockwise (about two full rotations).





- 2) Hold the hex key firmly and tighten the two M4 screws holding the hub.



- 3) Pull out the hose completely and check the rewinding speed.

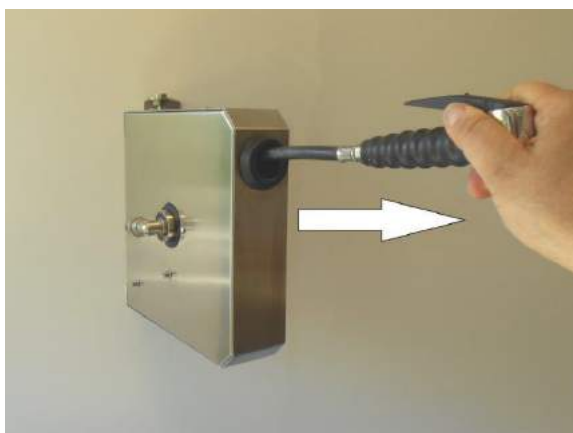

- 4) If the hose is rewound too fast, hold the hub with the 8 mm hex key, loosen the two screws, turn counterclockwise  $\frac{1}{2}$  turn, and tighten the screws again. Pull out the hose completely and check the rewinding speed.
- 5) If the rewinding is too slow, hold the hub with the 8 mm hex key, loosen the two screws, turn clockwise  $\frac{1}{2}$  turn, and tighten the screws again. Pull out the hose completely and check the rewinding speed.

### 13.6. Removing-replacing the hose on the pulleys



**Before starting any operation, shut down the water supply upstream of the MIDIReel and disconnect the water inlet hose.**



**Before starting any operation, the retraction spring should be completely unloaded (see instructions in the relevant paragraph).**



This operation can be carried out when the MIDIREel is mounted on its wall bracket. However, it is suggested to remove the MIDIREel and perform the operation on a workbench.

13.6.1. Removing the hose on the pulleys

- 1) Open the covers following the instructions described in the corresponding paragraph.
- 2) Unscrew the rubber connection to the shaft with a 19 mm spanner.



- 3) Unscrew the spray valve.



4) Disconnect the hose from the shaft.

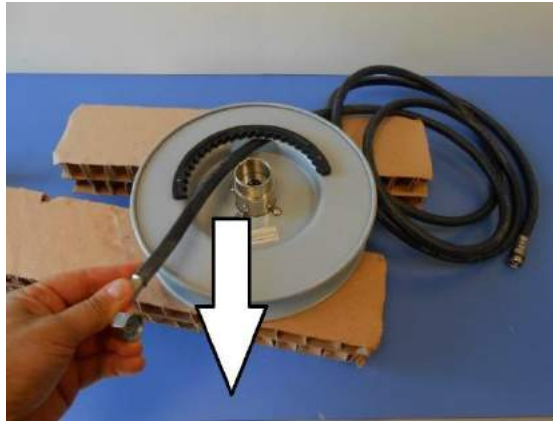

13.6.2. Replacing the hose on the pulleys

1) Pass the hose through the slot of the pulley.

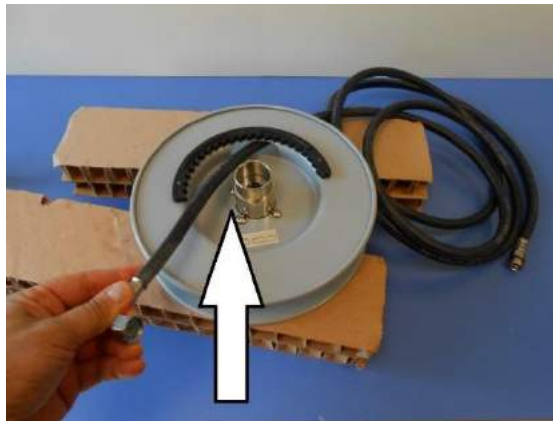

2) Using a 19mm spanner, screw the rubber coupling to the shaft.

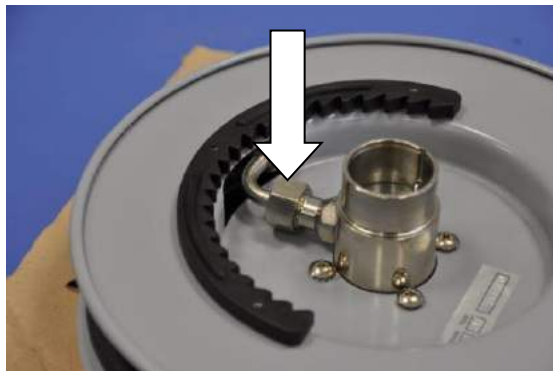

- 3) Roll the tube onto the pulley and pass the lug over the socket on the side of the MIDIREel.

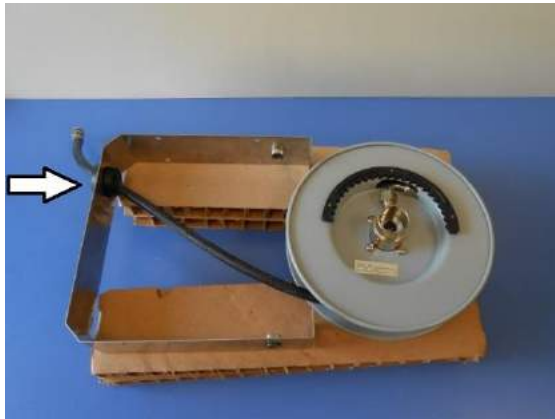

- 4) Screw on the spray gun.

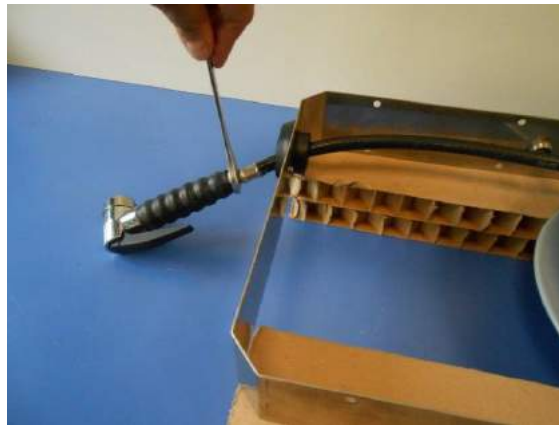

- 5) Close the lids according to the instructions in the relevant paragraph.
- 6) Load the retraction spring following the instructions in the relevant paragraph.

### 13.7. Removing-replacing the tooth spring



**Before starting any operation, shut down the water supply upstream of the MIDIREel and disconnect the water inlet hose.**

- 1) Open the lids as indicated in the instructions in the corresponding paragraph.
- 2) Loosen the spring tensioning screws.

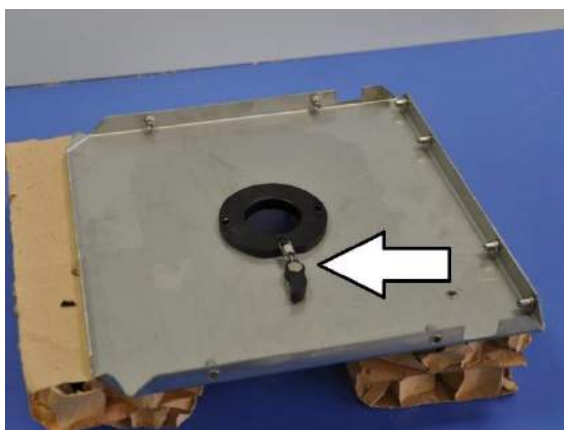

- 3) Place the new spring assembly.
- 4) Screw in the spring tensioning screw.

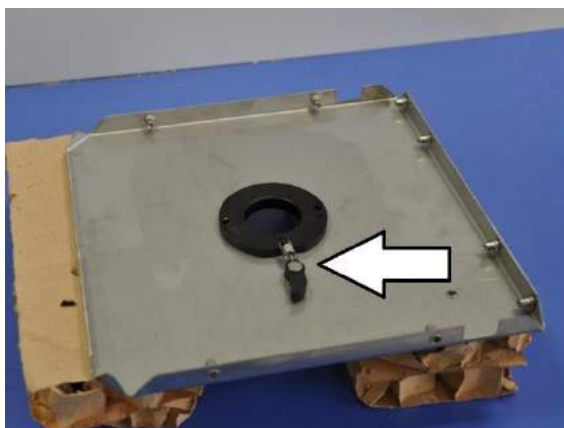

- 5) Close the lids as indicated in the instructions in the corresponding paragraph.
- 6) Load the reel spring according to the instructions in the relevant paragraph.

### 13.8. Extraordinary maintenance



**Extraordinary maintenance must be carried out only by qualified personnel having read the relevant Annex to this Manual.**



**Only specially trained personnel can open the MIDIREel spring cover, loosen or remove the screws. Failure to comply with these instructions may be a potential danger to the operator's safety.**



**In the event of a malfunction, the user must contact qualified personnel.**

For extraordinary maintenance operations, please refer to the relevant Annex to this Manual.

## 14. Disposal of the machine and its products



As rules may be different from country to country, the requirements imposed by national laws and authorities must be complied with. The following rules apply to Italy.

Machine disposal complies with the following regulations in force:

Directive 2008/98/EC on waste;

Directive 94/62/EC on packaging and packaging waste;

Directive 2004/12/EC amending directive 94/62/EC;

Directive 2005/20/EC amending directive 94/62/EC;

Directive 2018/852/EC amending directive 94/62/EC.



The machine data plate, the CE marking plate and the documentation provided at the time of purchase should be destroyed upon machine disposal.

## 15. Residual risks

### 15.1. Introduction

Risk assessment on the partly completed machine has been made according to the provisions of the harmonized standard UNI EN ISO 12100.

According to the risk assessment, the partly completed machine has been designed and constructed in such a way that **it can be installed and maintained** without putting persons at risk when these operations are carried out under the conditions foreseen and the instructions herein prescribed.

As for the use of the partly completed machine, it cannot be put into service until the industrial plant/final machinery where it will be incorporated and of which it will be part has been identified and complies with the provisions of Directive 2006/42/EC, as amended.

Based on the analysis made, the following is a list of residual risks that must be taken into account by the assembler when analyzing the entire plant/final machinery (in all its life phases).

List of risks:

- transport risks,
- risks due to assembly errors,
- risks due to poor lighting,
- risks of slipping and falling,
- risks during maintenance.

In addition to the above-mentioned risks, other residual risks should be considered during maintenance due to specific requirements for access to inaccessible or protected areas of the partly completed machine.

### 15.2. Transport risks

**Hazard risk of:** fall of the machine during transport.

**Prevention:** please refer to the instructions in the transport chapter.

### 15.3. Risks due to assembly errors

**Hazard risk of:** incorrect assembly or connection.

**It is forbidden to:** operate on machine parts without making reference to the technical drawings.

**Prevention:** entrust maintenance operations to qualified personnel.



#### **15.4. Risks due to poor lighting**

**Hazard risk of:** bumping against machine parts during maintenance, assembly or disassembly of hard-to-access parts.

**Warning:** it is absolutely forbidden to use the machine, carry out maintenance, adjustments, etc. in case of poor lighting.

**Prevention:** in case of maintenance operations performed in areas and/or parts of the machine with poor lighting, it is compulsory to have a portable lighting system to avoid shadow cones preventing or reducing visibility in the operating area or nearby zones.

#### **15.5. Risks of slipping and falling**

**Hazard risk of:** slipping due to water on the floor.

**Prevention:**

- use anti-slip safety footwear;
- entrust operation and maintenance to skilled personnel.

#### **15.6. Risks during maintenance**

**Hazard risk of:**

- slipping due to water on the floor;
- bumping/cutting oneself after opening the spring cover.

**Warning:** it is forbidden to open the MIDIREel spring cover and to loosen or remove any screws.

**Prevention:**

- entrust operation and maintenance to skilled personnel;
- use appropriate PPE as indicated in the Manual.

# 16. Annexes

- Annex 1:     Extraordinary maintenance
- Annex 2:     Machine technical drawings
- Annex 3:     .....
- Annex 4:     .....
- Annex 5:     .....
- Annex 6:     .....

## 17. Annex 1 - Extraordinary maintenance



Extraordinary maintenance must be carried out only by qualified personnel having read the relevant Annex to this Manual.



Only specially trained personnel can open the MIDIReel spring cover, loosen or remove the screws. Failure to comply with these instructions may be a potential danger to the operator's safety.



In the event of a malfunction, the user must contact qualified personnel.

### 17.1. Opening-Closing the shells



Before starting any operation, shut down the water supply upstream of the MIDIReel and disconnect the water inlet hose.



Operators must wear safety goggles during maintenance when disassembling the retraction spring.



Operators must use protective gloves during maintenance against cut hazards.

17.1.1. Opening the shells

**Before starting any operation, the retraction spring should be completely unloaded.**

- 1) Remove the MIDiReel from its wall bracket by unscrewing the two screws on the holding pins.

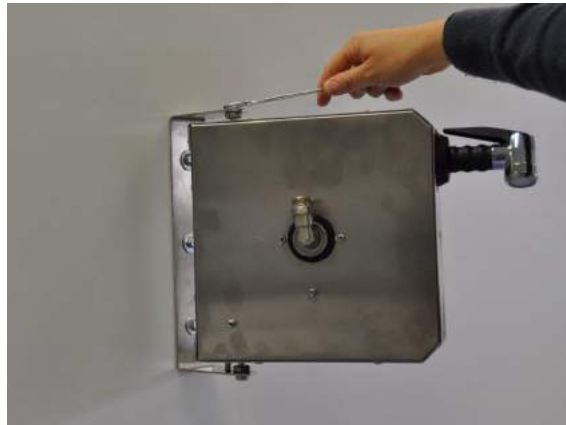

- 2) Place it horizontally on a workbench.

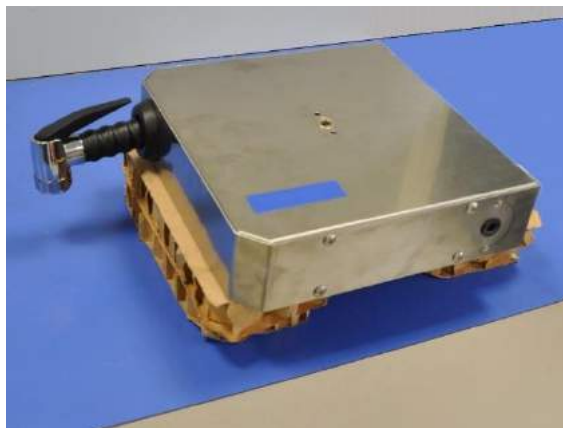

- 3) Remove the 14 side screws holding the shells together.



4) Lift the shell.

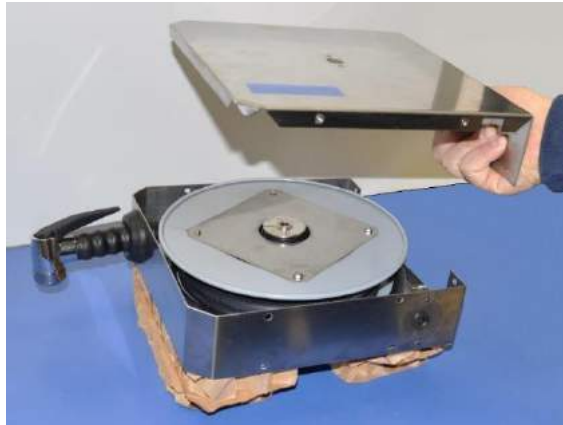

5) Take out the pulley assembly from the casing.

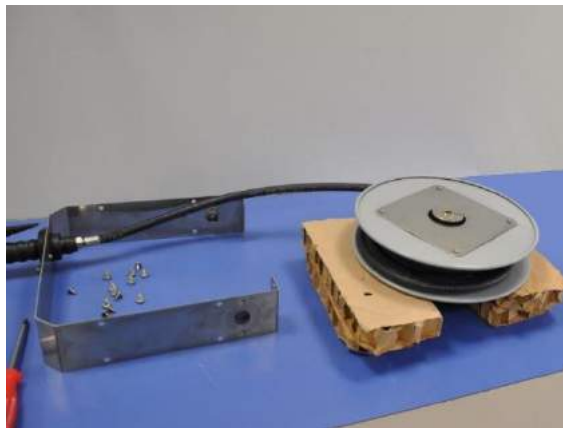

#### 17.1.2. Closing the shells

1) Place the shell with the inlet connector on the workbench.

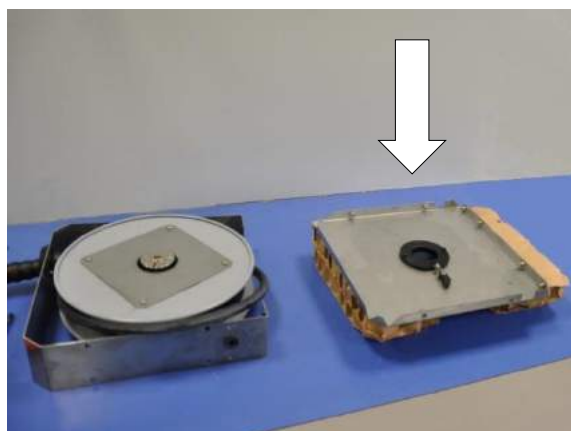

- 2) Assemble the pulley assembly, the side band and the other shell. Ensure the correct position of the side band in relation to the covers.



- 3) Insert and tighten the 14 side screws that hold the covers and the side together.



- 4) 4) Reinsert the two pins of the MidiReel between the holes in the bracket and lock the MidiReel in place.



## 17.2. Replacing the retraction spring



**Before starting any operation, shut down the water supply upstream of the MIDiReel and disconnect the water inlet hose.**



**Operators must wear safety goggles during maintenance when disassembling the spring.**



**Operators must use protective gloves during maintenance against cut hazards.**



**Use caution when removing and inserting the hose reel spring, as it may seriously injure the operator or cause damage to nearby objects.**

### 17.2.1. *Disassembling the retraction spring*



**Before starting any operation, the retraction spring should be completely unloaded.**

Once the shells have been removed as indicated in the previous paragraph, proceed as follows.

- 1) Unscrew the four M4 screws holding the spring cover and remove it.  
Unroll the hose if necessary.

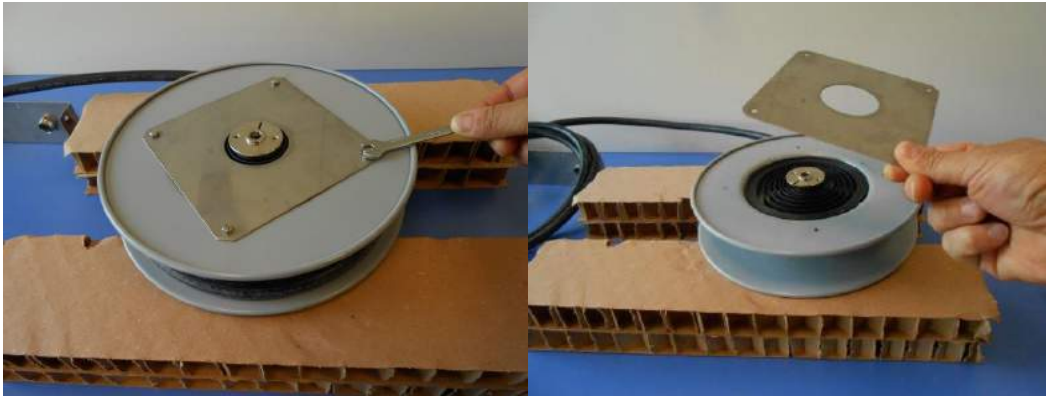

- 2) Unscrew the central screw inside the central hub.

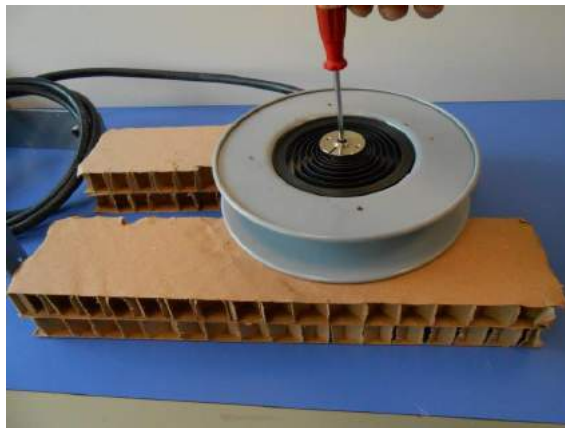

- 3) Remove the central hub.





- 4) Remove the retraction spring.



#### 17.2.2. Assembling the retraction spring

- 1) Assemble the new spring, taking care to fit its protruding edge into the slot on the pulley.

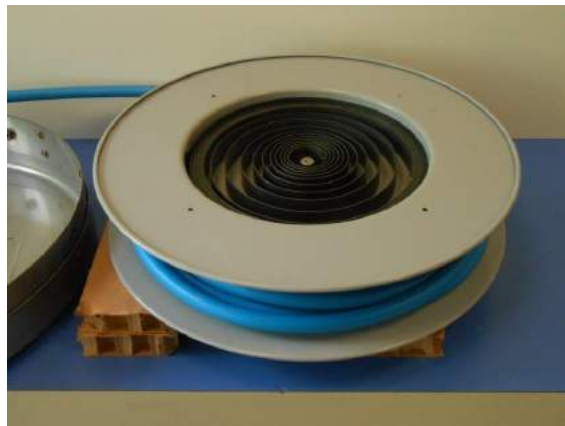

- 2) Assemble the hub and hook the central spring flap on the slot in the hub.



- 3) Tighten the central screw inside the hub.

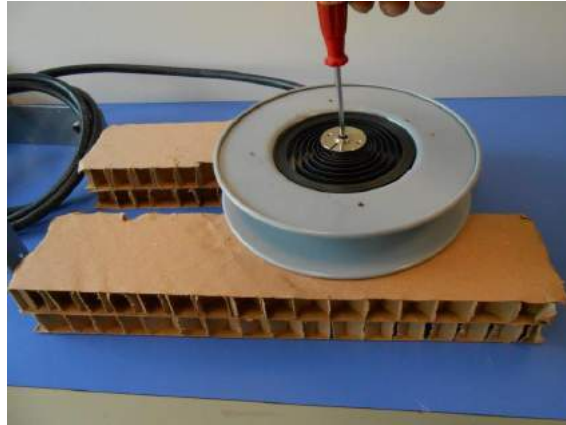

4) Assemble the spring cover and tighten the four M4 screws.



5) Close the shells following the instructions in the relevant paragraph.

6) Load the retraction spring following the instructions in the relevant paragraph.

# 18. Annex 2 - Machine technical drawings

3M — 4M

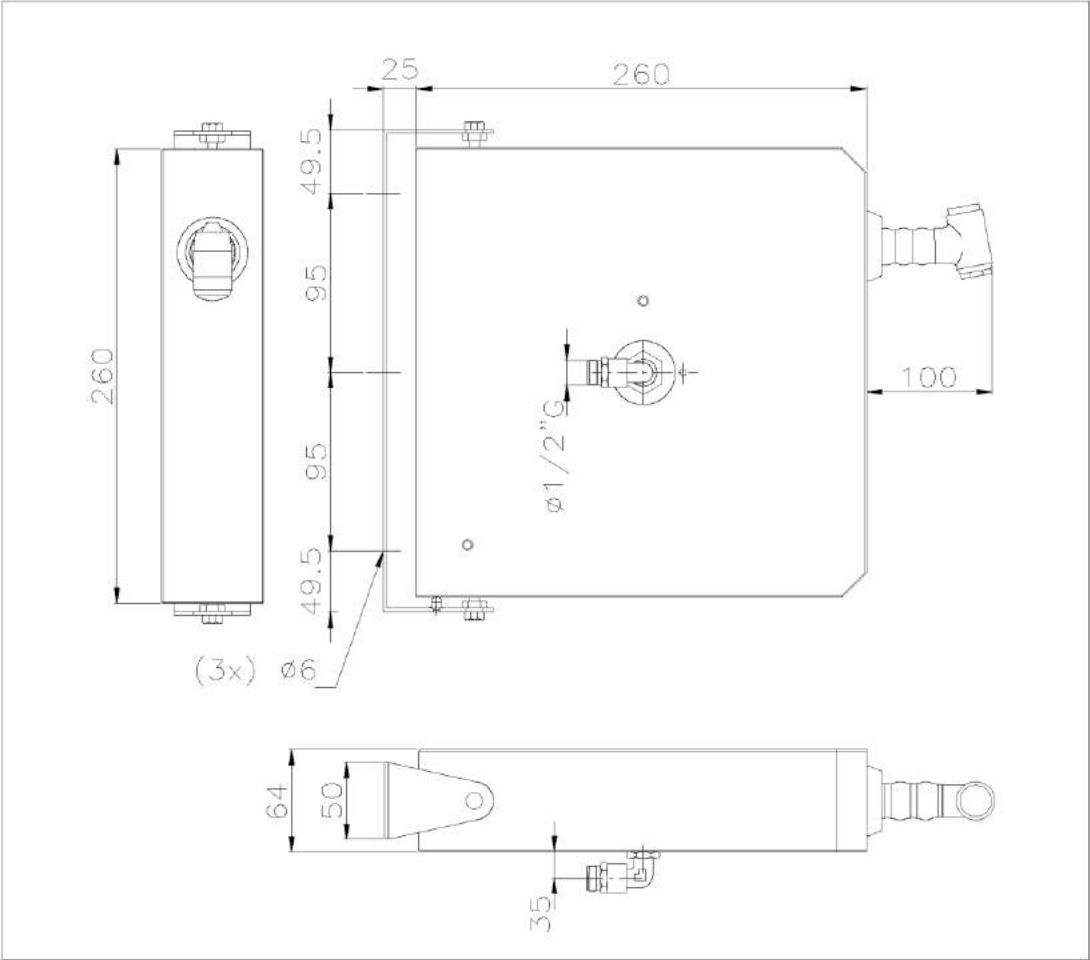

6M

